



SolarEdge

StorEdge Interface Installation Guide

**For the S1/S2 StorEdge Interface with LG
Chem Batteries and Single Phase
non-HD-Wave Inverters**

For Europe, APAC, Australia & South Africa

Version 1.4

Disclaimers

Important Notice

Copyright © SolarEdge Inc. All rights reserved.

No part of this document may be reproduced, stored in a retrieval system or transmitted, in any form or by any means, electronic, mechanical, photographic, magnetic or otherwise, without the prior written permission of SolarEdge Inc.

The material furnished in this document is believed to be accurate and reliable. However, SolarEdge assumes no responsibility for the use of this material. SolarEdge reserves the right to make changes to the material at any time and without notice. You may refer to the SolarEdge web site (www.solaredge.com) for the most updated version.

All company and brand products and service names are trademarks or registered trademarks of their respective holders.

Patent marking notice: see <http://www.solaredge.com/patent>

The general terms and conditions of delivery of SolarEdge shall apply.

The content of these documents is continually reviewed and amended, where necessary. However, discrepancies cannot be excluded. No guarantee is made for the completeness of these documents.

The images contained in this document are for illustrative purposes only and may vary depending on product models.

Emission Compliance

This equipment has been tested and found to comply with the limits applied by the local regulations. These limits are designed to provide reasonable protection against harmful interference in a residential installation. This equipment generates, uses and can radiate radio frequency energy and, if not installed and used in accordance with the instructions, may cause harmful interference to radio communications. However, there is no guarantee that interference will not occur in a particular installation. If this equipment does cause harmful interference to radio or television reception, which can be determined by turning the equipment off and on, you are encouraged to try to correct the interference by one or more of the following measures:

- Reorient or relocate the receiving antenna.
- Increase the separation between the equipment and the receiver.
- Connect the equipment into an outlet on a circuit different from that to which the receiver is connected.
- Consult the dealer or an experienced radio/TV technician for help.

Changes or modifications not expressly approved by the party responsible for compliance may void the user's authority to operate the equipment.

Contents

Disclaimers	1
Important Notice	1
Emission Compliance	1
Contents	2
HANDLING AND SAFETY INSTRUCTIONS	3
Safety Information	3
IMPORTANT SAFETY INSTRUCTIONS	3
Chapter 1: Overview	5
The StorEdge Solution Components	5
Installation Workflow	6
Installation Equipment List	7
Chapter 2: Meter Installation	8
Chapter 3: StorEdge Interface Installation	10
Unpacking and Identifying the Product	10
Mounting the StorEdge Interface	10
Connecting the StorEdge Interface	11
Connecting the StorEdge Interface to the Inverter	11
Connecting the StorEdge Interface to AC	14
Connecting the StorEdge Interface to the Battery Pack	14
DIP Switch Setup	17
Chapter 4: System Configuration	20
Upgrading the Inverter Firmware Version	20
Configuring the RS485 Bus for Battery and Meter Connection	21
Configuring StorEdge Applications	24
Maximize Self-consumption (MSC)	24
Profile Programming (for time-of-use arbitrage)	25
Starting-up the System	25
Appendix A: Troubleshooting	26
Communication Troubleshooting	26
Device type, number and protocol are displayed incorrectly	26
Troubleshooting Ethernet Communication	26
Meter Troubleshooting	27
<OK> is not displayed	27
An error message is displayed	27
Power [Wh] Import value is not advancing	27
Battery Troubleshooting	28
StorEdge Interface LEDs	29
Appendix B: Additional Battery Connections	30
Appendix C: StorEdge Interface Technical Specifications	31

HANDLING AND SAFETY INSTRUCTIONS

During installation, testing and inspection, adherence to all the handling and safety instructions is mandatory. **Failure to do so may result in injury or loss of life and damage to the equipment.**

Safety Information



WARNING!

Denotes a hazard. It calls attention to a procedure that, if not correctly performed or adhered to, could result in **injury or loss of life**. Do not proceed beyond a warning note until the indicated conditions are fully understood and met.



CAUTION!

Denotes a hazard. It calls attention to a procedure that, if not correctly performed or adhered to, could result in **damage or destruction of the product**. Do not proceed beyond a caution sign until the indicated conditions are fully understood and met.



NOTE

Denotes additional information about the current subject.



IMPORTANT SAFETY FEATURE

Denotes information about safety issues.

IMPORTANT SAFETY INSTRUCTIONS

SAVE THESE INSTRUCTIONS



WARNING!

The inverter cover must be opened only after shutting off the inverter ON/OFF switch located at the bottom of the inverter. This disables the DC voltage inside the inverter. Wait five minutes before opening the cover. Otherwise, there is a risk of electric shock from energy stored in the capacitors.



WARNING!

Do not remove the StorEdge Interface cover before five minutes have elapsed after disconnecting all sources of power, and shutting OFF the inverter and the StorEdge Interface.



WARNING!

Before operating the system, ensure that the power cable and wall outlet have been grounded properly.



WARNING!

When handling the battery, adhere to all manufacturer safety instructions.

WARNING!

The battery should be powered OFF before and during wiring. Turn OFF:

- The auxiliary power supply switch
- The circuit breaker switch

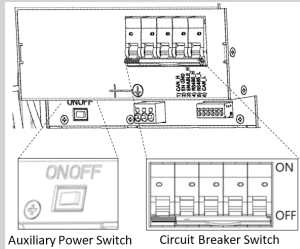

CAUTION!

This unit must be operated under the specified operating conditions as described in the technical specifications supplied with the unit.



NOTE

The battery used must be NRTL certified.



NOTE

For battery decommissioning and disposal, follow the manufacturer requirements and instructions.



NOTE

The StorEdge Interface is IP65 rated. Unused connectors and glands should be sealed with the provided seals.



NOTE

The  symbol appears at grounding points on the SolarEdge equipment. This symbol may also be used in this manual.



Chapter 1: Overview

SolarEdge's StorEdge™ solution for Smart Energy Management uses the StorEdge Interface to connect the battery to the inverter.

Power is stored in the battery and can be used for various applications such as maximized self-consumption and time of use profile programming. For backup power, an inverter specifically designed for backup applications is required; this inverter is not in the scope of this document.

The StorEdge Solution Components

- **The SolarEdge Inverter**
- **The SolarEdge Meter** - The meter is used by the inverter for export/ consumption readings, and for Smart Energy Management applications, such as: export limitation and maximizing self-consumption.
- **The StorEdge Interface** - The StorEdge Interface connects the battery to the inverter through fuses, and supplies control and monitoring signals to the battery for operation.
- **One battery** - DC coupled batteries designed to work with the SolarEdge system.

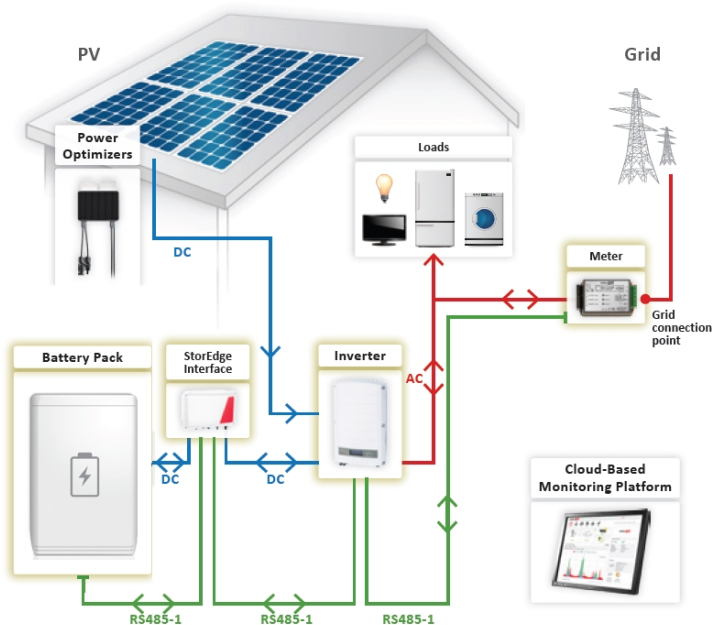

Figure 1: StorEdge system components

NOTE

- Additional SolarEdge inverters (without batteries) can be connected with RS485. The inverters will participate in export limitation and Smart Energy Management. Connecting multiple inverters with RS485 master-slave connection may require an *RS485 Expansion Kit* (available from SolarEdge).
- PV modules connected to power optimizers are not mandatory for charge/ discharge profile programming.



Installation Workflow

When installing the StorEdge system, follow this workflow to ensure all the components are connected and functioning correctly.

Plan the StorEdge system layout:

- The battery and StorEdge Interface will connect to the DC side of the inverter. Since the inverter DC connections are on its left side, it is recommended to position the battery and interface to the left of the inverter to simplify wiring.
- To simplify cable management, a minimum distance of 1.5m between battery and interface is recommended.

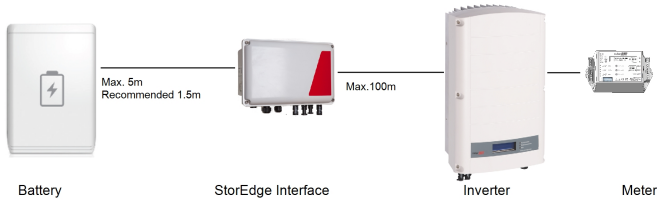
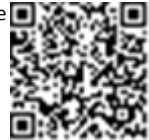

Figure 2: System Layout

Step 1 - PV system installation - modules, power optimizers and inverter(s). Refer to the following chapters of the *SolarEdge Installation Guide* supplied with the inverter and available at <http://www.solaredge.com/files/pdfs/products/inverters/guides/se-inverter-installation-guide.pdf>:

- Installing the Power Optimizers (if applicable)
- Installing the Inverter
- Connecting the AC and the Strings to the Inverter
- Activating the inverter- as described in the **Commissioning** chapter of the *SolarEdge Installation Guide*, using the activation card supplied with the inverter.
- Upgrading the inverter firmware version, using the upgrade card supplied with the StorEdge Interface.
- Pairing the system - as described in the **Commissioning** chapter of the *SolarEdge Installation Guide*
- Setting Up Communication



Step 2 - Electricity Meter installation (required for Smart Energy Management). Refer to *Meter Installation* on page 8.

Step 3 - StorEdge Interface installation and connection as described in *StorEdge Interface Installation* on page 10.

Step 4 - Connect the battery to the StorEdge Interface and mount the battery. Refer to the installation information in the manufacturer documentation, and to *Connecting the StorEdge Interface to the Battery Pack* on page 14.

Step 5 - Configuring the communication between the inverter and the other devices (meter, battery, etc.). Refer to *Configuring the RS485 Bus for Battery and Meter Connection* on page 21.

Step 6 - System Configuration - Configuring the RS485 bus and StorEdge applications. Refer to *System Configuration* on page 20.

Installation Equipment List

Standard tools can be used during the installation of the SolarEdge system. The following is a recommendation of the equipment needed for installation:

- Standard flat-head screwdrivers set
- Non-contact voltage detector
- Suitable hardware for attaching the inverter mounting bracket to the surface to which it will be connected
- Wire cutters
- Wire strippers
- Voltmeter

For installing the communication options, you may also need the following:

- For Ethernet:
 - CAT5/6 twisted pair Ethernet cable with RJ45 connector.
 - If using a CAT5/6 cable spool: RJ45 plug and RJ45 crimper
- For RS485:
 - Four- or six-wire shielded twisted pair cable.
 - Watchmaker precision screwdriver set

Chapter 2: Meter Installation

The StorEdge solution requires connecting a meter for Smart Energy Management applications, such as export limitation and maximizing self-consumption.

The meter type (single or three phase) and number of current transformers (CTs) should be selected per the grid connection and energy management application rather than according to the inverter model. The CTs are supplied with 2m twisted pair wires for connecting the CTs.

To install the SolarEdge meter, refer to the installation guide supplied with it:
<http://www.solaredge.com/files/pdfs/solaredge-meter-installation-guide.pdf>.

The meter is connected to the inverter using RS485.

RS485 wiring specifications:

- Cable type: Min. 3-wire shielded twisted pair (a shielded Ethernet cable (Cat5/5E STP) may be used)
- Wire cross-section area: 0.2-1 mm² / 24-18 AWG (a CAT5 cable may be used)



NOTE

The inverter RS485 bus should be connected to the battery (via the StorEdge interface) and meter. Connecting multiple inverters (or an external logger) with RS485 master-slave connection may require an RS485 Expansion Kit (available from SolarEdge; Refer to http://www.solaredge.com/files/pdfs/RS485_expansion_kit_installation_guide.pdf).



► To connect the meter to the inverter:

1. Remove the seal from one of the openings in communication gland at the bottom of the inverter and insert the RS485 wires from the meter through the opening.

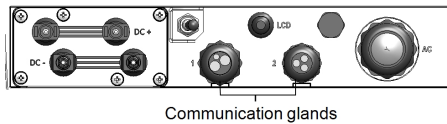

Figure 3: Communication glands

2. Pull out the RS485 connector located on the communication board.

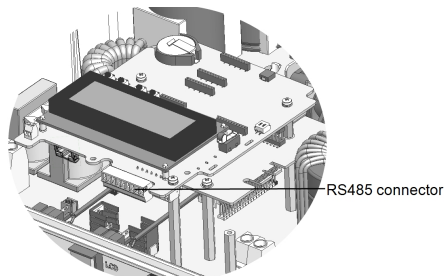

Figure 4: Inverter RS485 connector

3. Connect the wires as illustrated below:

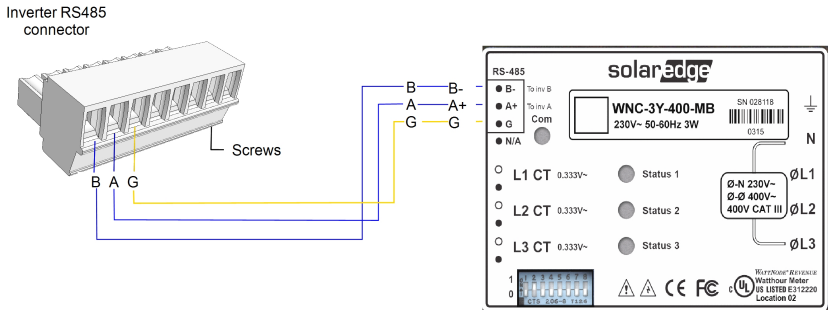

Figure 5: Meter RS485 connections

4. Terminate the last device in the RS485 chain (see also *DIP Switch Setup* on page 17):

- If the inverter is at the end of the RS485 bus, switch a termination DIP-switch inside the inverter to ON (top position). The switch is located on the communication board as follows:

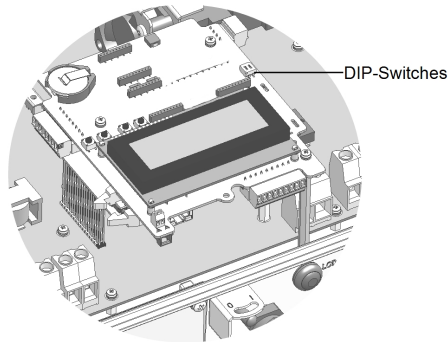

Figure 6: RS485 termination switch

- If the meter is at the end of the RS485 chain and has a termination switch, it should be terminated using its DIP switches (see also *DIP Switch Setup* on page 17).

Chapter 3: StorEdge Interface Installation

Unpacking and Identifying the Product

An identification label with product specifications is attached to each device.

Check the equipment for damage before starting installation: There are no loose parts. All parts are either mounted or located in the accessory kit. If any damage is found, document the damage, and contact SolarEdge.

Mounting the StorEdge Interface

- Determine the StorEdge Interface mounting location, on a wall or pole, as follows:
 - Maximum distance from the battery: 5m (15 ft)
 - Maximum distance from the inverter: 100m (328 ft)
 - Maintain a minimum 20 cm (8") clearance between the StorEdge Interface and other objects.

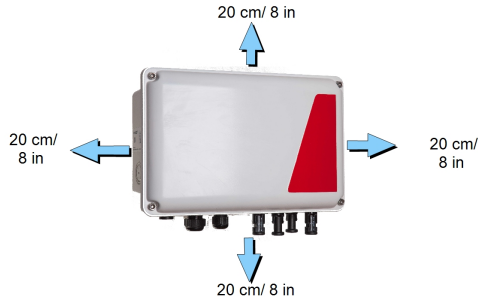

Figure 7: StorEdge Interface clearance

- Install the bracket with the semi-circles facing down, as shown below. Verify that the bracket is firmly attached to the mounting surface.

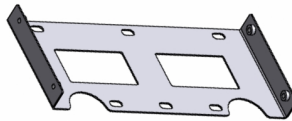

Figure 8: Mounting bracket

- Install the interface: Attach the StorEdge interface back brackets to the mounted bracket using the four supplied screws. Tighten the screws with a torque of 9 N*m / 6.6 lb*ft.

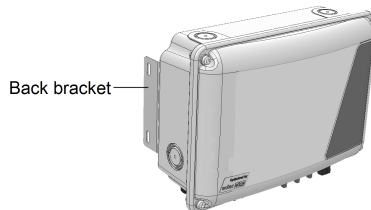

Figure 9: The StorEdge Interface

- Loosen the 4 Allen screws of the StorEdge Interface and remove the cover.

Connecting the StorEdge Interface

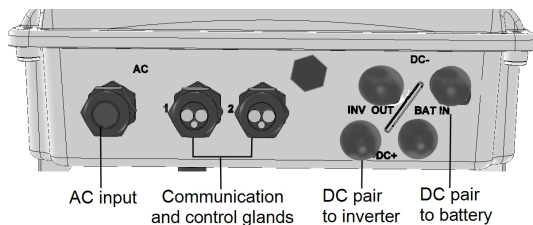

Figure 10: StorEdge Interface connectors

Connecting the StorEdge Interface to the Inverter

▶ To connect to the inverter DC:

1. Prepare one pair of DC cables with MC4 connectors at both ends - male at one end and female at the other end.
2. Connect one end of the cables to the inverter, and connect the other end to the DC+ and DC- input connectors marked **INV OUT**.



NOTE

If all the inverter DC inputs are connected to PV strings, use a branch cable (available from SolarEdge) to connect the StorEdge Interface to the inverter DC input.

▶ To connect RS485 communication between the inverter and StorEdge Interface:

RS485 wiring specifications:

- Cable type: Min. 3-wire shielded twisted pair (a shielded Ethernet cable (Cat5/5e STP) may be used)
 - Wire cross-section area: 0.2- 1 mm²/ 24-18 AWG (a CAT5 cable may be used)
1. Connect one end to the RS485 terminal block marked "RS485 to Inv." in the StorEdge Interface (see *Figure 11*):
 - a. Open gland #2.
 - b. Remove the seal from one of the openings and insert the wire through the opening.

- c. Connect the wire ends in the **A**, **B** and **G** pins (use a twisted pair for A and B): Use a flat blade screwdriver to press the protrusion at the top of the terminal block and open the connection hole; insert the wire and release to spring back and clamp the wire.

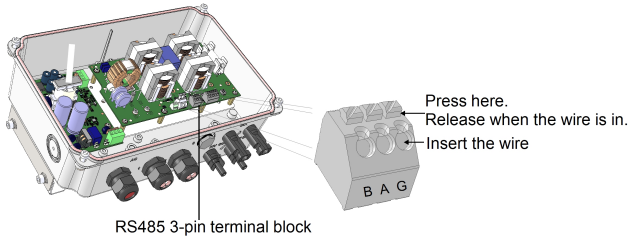

Figure 11: RS485 connector in the StorEdge Interface

You can use any color wire for each of the **A**, **B** and **G** connections, as long as the same color wire is used for both A pins (inverter and StorEdge Interface, the same color for both B pins and the same color for both G pins.

2. Connect the other end of the communication cable to the inverter communication board:



NOTE

The wires from the meter and from the StorEdge Interface are inserted into the same pins in the inverter RS485 terminal block. Make sure that the meter wires are not disconnected when inserting the Interface wires.

- a. Open the inverter cover as described in its manual.
- b. Remove the seal from one of the openings in the communication gland and insert the wire through the opening.

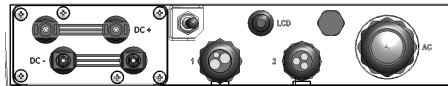

Communication glands

Figure 12: Inverter Communication glands

- c. Pull out the 9-pin RS485 terminal block connector, as shown below:

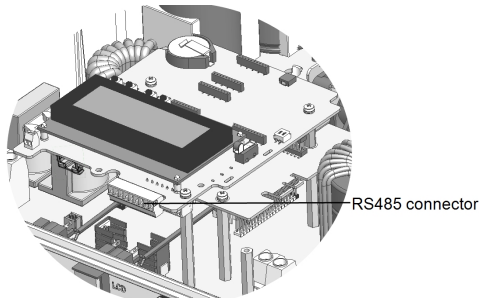

Figure 13: Inverter RS485 terminal block

- d. Loosen the screws of pins A(+), B(-), and G on the left of the RS485 terminal block.

e. Insert the wire ends into the **G**, **A** and **B** pins.

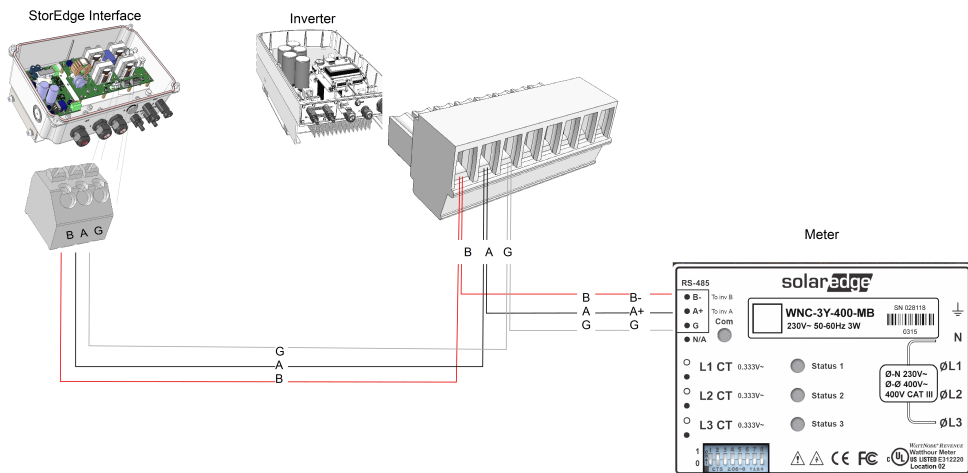

Figure 14: Connections to the inverter and meter

3. Check that the wires are fully inserted and cannot be pulled out easily.

Connecting the StorEdge Interface to AC



NOTE

The AC is used for auxiliary power only and does not carry high power.

Use a three-wire cable with a cross section of 1-2mm².

► To connect to AC:

1. Turn OFF the AC power source to be connected to the interface.
2. Remove the interface AC sealing gland.
3. Strip off 5/16" (8mm) of the AC cable insulation and expose two line wires and one grounding wire.
4. Insert the wire ends into the AC terminals (L, N), and the grounding terminal according to the labels.

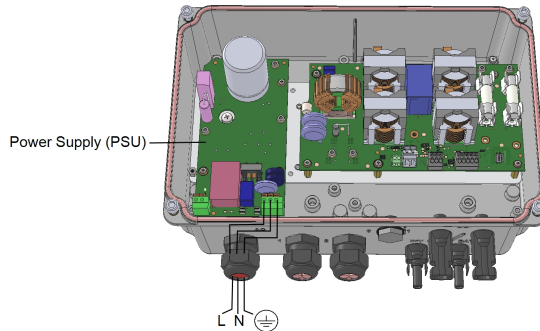

Figure 15: AC and grounding connections

Connecting the StorEdge Interface to the Battery Pack

WARNING!

The battery should be powered OFF before and during wiring. Turn OFF:

- The auxiliary power supply switch
- The circuit breaker switch

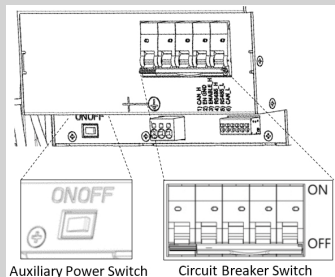

Before installing the battery pack according to the instructions provided by the battery manufacturer, connect the battery to the StorEdge Interface as described in this section.

Follow these guidelines:

- For easy access to battery connectors, it is recommended to connect the cables to the battery and to set all the battery DIP switches to their correct positions while the battery is still on the ground, *before* mounting the battery according to the manufacturer instructions). The following procedure is recommended:
 - a. Connect all the wires to the battery connection panel
 - b. Mount the battery
 - c. Connect to the StorEdge Interface.
- Measure the necessary length between the StorEdge Interface and the battery for all cables.
- Tie and wrap the cables to avoid pulling them out during mounting.
- Be sure to adhere to all safety cautions and information in the battery documentation.

The following table, *Figure 20* detail cable types and connections of the StorEdge Interface one with 2 DIP switches to one battery (LG-chem RESU7H/RESU10H). For additional information, refer to

http://www.solaredge.com/sites/default/files/storedge_interface_wiring_quick_guide_and_on_site_checklist_for_lg_batteries.pdf.



► **To connect the battery pack and the StorEdge Interface:**

1. Prepare cables and connect as described in the following table; Pay attention to the wire colors (see *Figure 20*):

Recommended cable type (min-max cross section)	StorEdge Interface connection	LG Chem RESU7H/RESU10H battery connection (<i>Figure 16</i>)	Connection method in StorEdge Interface
DC			
One pair of PV DC cables with a cross section of 6 (4-6)mm ² , 600V insulated, with MC4 connectors at one end.	BAT DC +	DC+	MC4 connection
	BAT DC -	DC-	MC4 connection
Control and monitoring			
	5-pin communication terminal block:	6-pin connector	
5-wire shielded twisted pair cable with a cross section of 0.2 (0.2 - 1.5) mm ² . A CAT5 600V insulated cable can also be used.	En (Enable)	ENABLE_H	Press the protrusion at the top of the terminal block to open the connection hole, insert the wire and release to spring back and clamp the wire. Refer to <i>Figure 16</i>
	V+	Not connected	
	B (RS485) ¹	RS485_H + ²	
	A (RS485) ¹	RS485_L - ²	
	G (RS485)	EN_G	

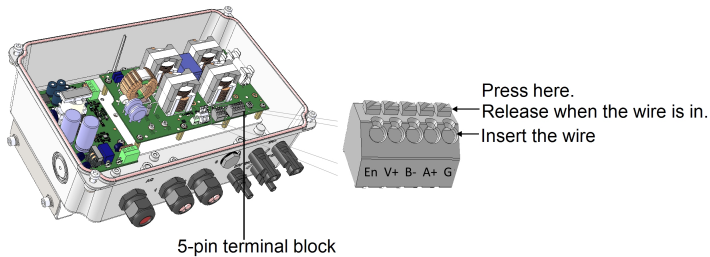

Figure 16: Connecting to the battery

2. Set the DIP switches as described in *DIP Switch Setup* on page 17.
3. Close the StorEdge Interface cover: Attach the cover and secure it by tightening the four screws with a torque of 1.2 N*m / 0.9 ft. *lb.

¹Must be twisted pair

²Must be twisted pair

DIP Switch Setup

Verify that the DIP switches on the system components are set as described in this section, according to the system hardware configuration. This section provides information about LG Chem RESU7H / RESU10 batteries.

Termination and bias guidelines:

- The last battery in the RS485 chain should have termination and bias.
- The last meter in the RS485 chain should be terminated with 120 Ohm (either internal or external).
- Inverter communication board should not have termination if meter is installed, otherwise ON.

Verify that the DIP switches of all the devices are set as described in the following table, according to the components used in the system and their location:

System Component	Communication and Termination Switches	Address Switches
Batteries		
LG Chem RESU7H / RESU10H	N/A	
StorEdge Interface		
StorEdge Interface main board	Communication DIP switches (if applicable, <i>Figure 17</i>): Up	N/A
Meters		
SolarEdge Meter (<i>Figure 18</i>)	<ul style="list-style-type: none"> ◦ If the meter is not the last in the chain - No termination ◦ Single meter or the meter is the last in the RS485 chain - 120 Ohm termination¹ on the last meter connected on the chain 	Meter 1 address: <ul style="list-style-type: none"> ◦ Switch 1: Up ◦ Other: Down Meter 2 address: <ul style="list-style-type: none"> ◦ Switch 2: Up ◦ Other: Down
Inverter		
Single phase inverters - inverter communication board (<i>Figure 19</i>)	<i>RS485-1 connection</i> - use SW7 DIP switch 1 (leftmost) <ul style="list-style-type: none"> ◦ If a meter is installed: SW7 Down - No termination ◦ If a meter is not installed: SW7 Up - termination ON. 	N/A

¹For installing an external 120 Ohm termination plug, contact SolarEdge Support .

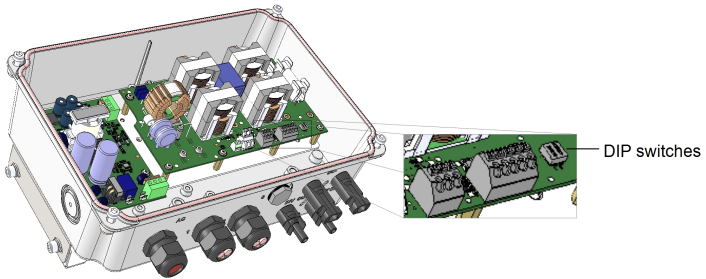

Figure 17: StorEdge Interface Communication DIP switches



Figure 18: SolarEdge Meter DIP Switches

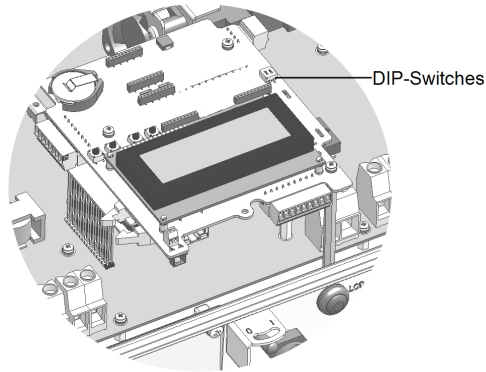

Figure 19: RS485 termination switch on the inverter communication board

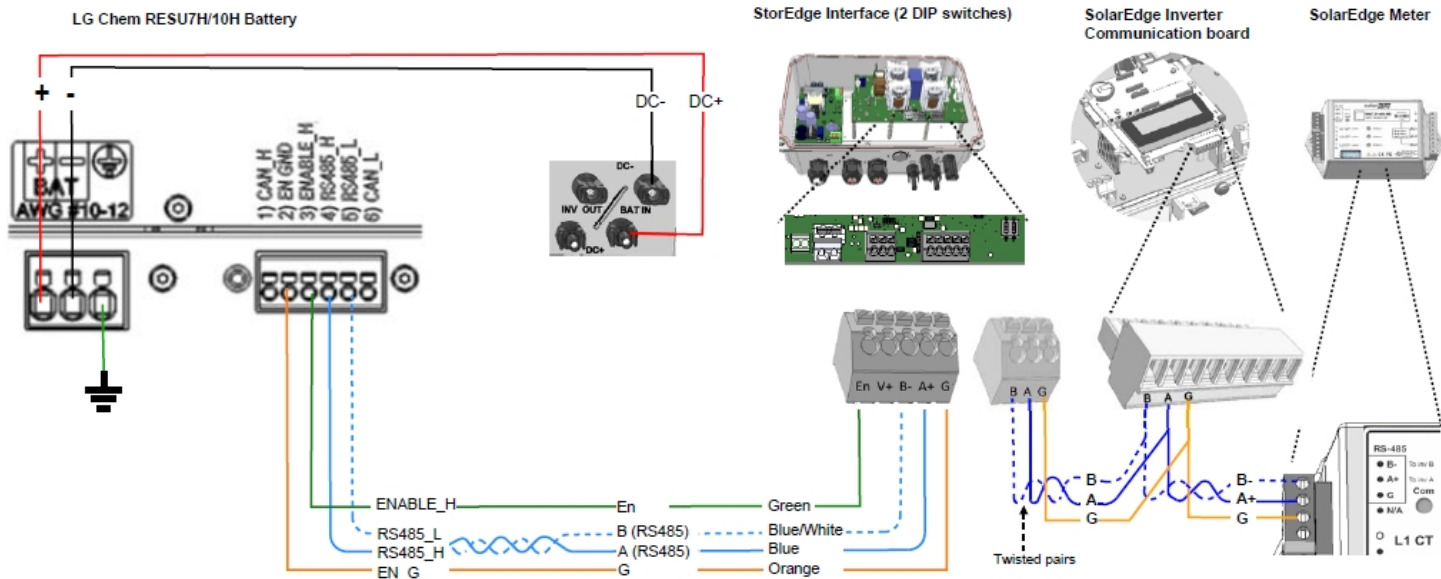

Figure 20: StorEdge Interface connections with SolarEdge inverter and LG Chem RESU7H / RESU10 battery

Chapter 4: System Configuration

This chapter describes how to configure your StorEdge system by setting up the communication between the system components and setting up the required application. To use the StorEdge applications, the inverter communication board firmware (CPU) version must be 3.xxxx and later. The latest firmware version is available for download at <http://solaredge.com/storedge/firmware>.

Upgrading the Inverter Firmware Version

Upgrade the inverter firmware using a MicroSD card with the latest firmware version downloaded from the above link .

► To upgrade the inverter firmware:

1. Make sure that:
 - The inverter has been activated using the activation card supplied with the inverter
 - The inverter ON/OFF switch is OFF
 - The AC voltage to the inverter is OFF
 - If applicable - the StorEdge Interface ON/OFF switch is OFF.
2. Remove the inverter cover.
3. Insert the card into the communication board slot marked "CARD".

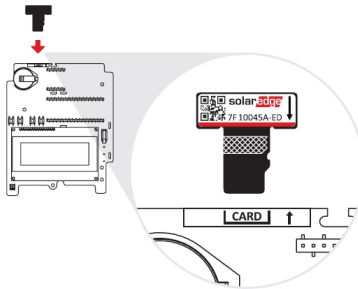

Figure 21: Inserting the upgrade card

4. Turn ON the battery AUX switch and circuit breaker. Wait 1 minute before proceeding.
5. Turn ON:
 - AC to the StorEdge Interface
 - AC to the inverter



WARNING!

ELECTRICAL SHOCK HAZARD. Do not touch uninsulated wires when the cover is removed.

6. Turn ON AC to the inverter.



WARNING!

ELECTRICAL SHOCK HAZARD. Do not touch uninsulated wires when the cover is removed.

7. The upgrade starts automatically. Wait for the message **Done** to be displayed on the LCD.
8. Remove the card from the inverter.

Configuring the RS485 Bus for Battery and Meter Connection

This section describes how to set up the RS485 communication between the inverter, meter, StorEdge Interface, and one battery.

► To configure the RS485 bus:

1. Turn the inverter ON/OFF switch to OFF.
2. Select **Communication** → **RS485-1 Conf** → **Device Type** → **Multi Devices**. A list of devices is displayed.

```
Device Type <MLT>
Meter 1 <---->
Meter 2 <---->
Meter 3 <---->
Battery 1 <---->
Battery 2 <---->
```

3. Select **Meter 2**. The meter configuration screen is displayed (SolarEdge meters are pre-configured to Device ID 2):

```
Device Type <MTR>
Protocol <WN>
Device ID <2>
CT Rating <0>
Meter Func. <None>
```

4. Configure the meter:
 - a. Select **Device Type** → **Revenue Meter**
 - b. Select **Protocol** → **WattNode**
 - c. Verify that **Device ID** is set to **2**.
 - d. Set the CT value that appears on the CT label: **CT Rating** → **<xxxxA>**.
If CT resets to 0, check the communication as described in step b of verify the connection:below.
 - e. For a meter installed at the grid connection point select **Meter Func.** → **Export+Import**.

```
Export+Import
Export
Consumption
Production
Ext. Production
Import
None
```

The selected option is displayed in the RS485 Conf screen as <E+I>.

5. Select **Communication** → **RS485-1 Conf** → **Device Type** → **Multi Devices** → **Battery 1**. The battery configuration screen is displayed:

```
Device Type <BAT>
Protocol <LG Battery>
Device ID <15>
Battery Info < >
```

6. Select **Device Type** → **Battery Pack**.
7. Select the battery protocol: **LG Battery**, and ID: **15**
8. To verify battery connection, select **Battery Info** and check that the battery information is displayed. If not, check the wiring to the battery:

```
SN: <serial #>
Model: <XXXXXX>
Nameplate [kWH]: N/A
FW Ver. <XXXXXX>
```

Make sure to have the battery serial number and firmware version at hand whenever contacting support.

► **To verify the connection:**

1. Turn the StorEdge Interface ON/OFF switch to ON.
2. Press the inverter external LCD light button to display the status screens one after the other:
 - a. Check the RS485 communication status:

```

Dev Prot ##
RS485-1 <MLT> <02><02>

```

- The **MLT** under **Dev** denotes that the configuration is for multiple devices.
- The number under **Prot** (protocol) should display the number of *configured* devices.
- The number under **##** should display the number of *detected* devices.

The above screen shows an example of 2 devices on the same bus (for example: meter and battery).

If the number of devices under Prot does not match the number under ##, refer to *Troubleshooting* on page 26.

- b. Check the meter(s): In the meter(s) status screen check that the status is **OK**. The following is an example of the status of an Export (or Export+Import) meter:

```

Export Meter
Status:      <OK/ Error#>
Power [W]:   xxxxx.x
Energy [Wh]: xxxxx.x

```

If **Comm. Error** appears, refer to *Troubleshooting* on page 26.

- c. Check the battery information: identification, charging status and power, and the operating mode.

```

BSN: XXXXXXXXXXXX ID:15
SOE: 89%          PWR: 2W
Total: <x>Wh
State: Charging

```

If **Comm. Error** appears, refer to *Troubleshooting* on page 26.

Configuring StorEdge Applications

This section describes the StorEdge applications and how to configure the system.

Maximize Self-consumption (MSC)

In this mode, the battery is automatically charged and discharged to meet consumption needs.

The battery has two states:

- OFF – the battery is in standby
- ON – the battery is controlled for maximized self-consumption

Battery OFF periods can be configured to extend battery lifetime by minimizing the number of shallow discharges (for example at nighttime or during the winter).

► To set up maximize self-consumption:

1. Enter Setup mode, scroll down to the **Power Control** menu and select it. A menu similar to the following is displayed:

```
Grid Control <En>
Energy Manager
RRCR Conf.
Reactive Pwr Conf.
Active Pwr Conf.
Phase Balance <Dis>
Wakeup Conf.
P(f)
Advanced
Load Defaults
```

2. Select **Energy Manager**. The following screen is displayed:

```
Limit Control<Dis>
Energy Ctrl <Dis>
Advanced
```

Limit Control: For power limitation (including export limitation) configuration. This option can be used in parallel to energy control. For more information refer to http://www.solaredge.com/files/pdfs/products/feed-in_limitation_application_note.pdf.

Energy Control: The method by which to manage the energy.

Advanced: For enabling external production

3. Select **Energy Ctrl.**. The following is displayed, showing the SolarEdge applications:

```
Max Self-consume
Time of Use
Disable
```

Max Self-consume (MSC): Maximize Self-consumption

Time of Use (TOU): Charge/Discharge Profile Programming

Disable: No energy control, that is, the battery is not used



4. For maximizing self consumption, select **Max Self-Consume**. The Energy Manager screen changes to display the following:

```
Limit Control <Dis>
Energy Ctrl <MSC>
Set Operation
Storage Ctrl
```

5. Optionally, set the battery OFF periods as follows:
- Select **Set Operation**. A list is displayed, allowing 12 monthly profile setup:

```
Jan <ON>
Feb <ON>
Mar <ON>
Apr <ON>
```

- Select a month. A list of options is displayed.

```
Start Time <00:00>
End Time <00:00>
Always ON
Always OFF
```

- Select one of the options:
 - Select **Always OFF** to avoid battery usage entirely (for example during winter)
 - Set **Start Time** and **End Time** to set battery usage in specific hours and avoid usage during specific hours throughout the month (for example at night). This sets the periods during which the battery will be in the OFF state.
 - Select **Always ON** to use battery at all times for charging/ discharging.

Profile Programming (for time-of-use arbitrage)

In this mode, the StorEdge system operates according to a configured charge/ discharge profile. This application is covered in a separate application note available at https://www.solaredge.com/sites/default/files/storedge_applications_connection_and_configuration_guide.pdf.



Starting-up the System

Upon installation and configuration completion, the power optimizers should be paired to the inverter. Close the inverter cover and perform pairing as described in the installation guide provided with your inverter.

Appendix A: Troubleshooting

This appendix describes how to troubleshoot StorEdge related errors.

Communication Troubleshooting

When a battery and a meter are connected (2 devices connected to the same bus), the following should appear in the Communication status screen:

```

Dev Prot ##
RS485-1 <MLT> <02><02>
ZigBee <---><---><--->

```

Device type, number and protocol are displayed incorrectly

If one or more of the following occurs, the meter(s) or the battery are not communicating with the inverter:

- If **Dev** is not **MLT** (Multi), the system is not pre-configured and requires full configuration. Configure the system as described in *Configuring the RS485 Bus for Battery and Meter Connection* on page 21.
- If **##** < 02, the meter and/or the battery are not configured correctly. Check the configuration.
- If **Prot** < 02, the meter and/or the battery is not communicating correctly. Check the configuration and wiring connection.

If Prot = ##– the battery and meter are configured and communicating properly.

Troubleshooting Ethernet Communication

When using Ethernet communication, use the **Server Communication Status** window to identify the location of the error:

```

Server: LAN <S_OK>
Status: <OK>
xxxxxxx
<ERROR MESSAGE>

```

xxxxxxx is a string of 1s and 0s showing an eight-bit communication connection status. 1 indicates OK and 0 indicates an error.

Bit Location	Error Message	Cause and Troubleshooting
1st	LAN Disconnected	Physical connection fault. Check the cable pin-out assignment and cable connection. Refer to <i>Creating an Ethernet (LAN) Connection</i> in the inverter installation guide.
2nd	DHCP Failed, or Invalid DHCP Config	IP settings issue. Check the router and configuration. Consult your network IT.
3rd	Gateway Ping Failed	Ping to router failed. Check the physical connection to the switch/router. Check that the link LED at the router /switch is lit (indicating phy-link). If OK - contact your network IT, otherwise replace the cable or change it from cross to straight connection.

Bit Location	Error Message	Cause and Troubleshooting
4th	G Server Ping Failed	Ping to google.com failed. Connect a laptop and check for internet connection. If internet access is unavailable, contact your IT admin or your internet provider.
5th	Server x Ping Failed	Ping or connection to SolarEdge server failed. Check the SolarEdge server address, under LAN Conf submenu: Address: prod.solaredge.com Port: 22222 Check with your network administrator whether a firewall or another device is blocking transmission.
6th		
7th		
8th	Tcp Connect. Failed	

Meter Troubleshooting

When a meter is connected, there will be a status screen for each meter function. The following is an example of the export meter function status:

```

Production Meter
Status :      <OK / Error>
Power [ W ] :      x x x x x . x
Energy [ Wh ] :      x x x x x . x
    
```

<OK> is not displayed

If <OK> is not displayed in the Status line of the status screens, the meter is not communicating with the inverter communication board. Check the following:

- There are no loose connections at the inverter communication board and at the meter.
- The wiring between the 4-pin terminal block on the meter and the RS485 terminal block on the StorEdge Interface is correct (refer to *Figure 20*).

An error message is displayed

If error code **3x6E** (or **Error 185**) - **Meter Comm. Error** is displayed in the meter status screen, verify proper connection of:

- The RS485 cables and connectors
- The AC connection of the meter

Power [Wh] Import value is not advancing

If the inverter is not producing power, and there is power consumption by the loads, check the following:

- The meter status LEDs are lit. If the LEDs are all OFF, the meter is not connected to a power source.
 - Check the meter AC connection (10-pin terminal block)
 - Check that the meter breaker is ON
- There are no loose connections at the 10-pin AC wiring of the meter.
- The CT black and white cables are correctly connected to the 6-pin connector on the meter:

- White CT wire is connected to L1 white
- Black CT wire is connected to L1 black
- CT direction is towards the grid and the green power LEDs are ON. If the LEDs are not green indicating import power - the CTs are reversed.

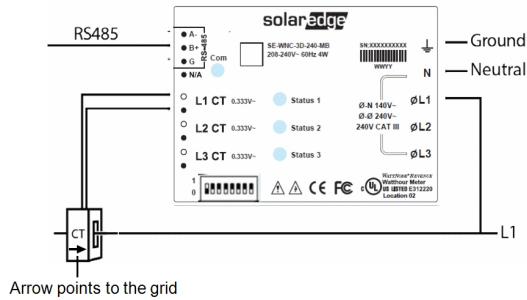

Figure 22: Meter with CT

Battery Troubleshooting

The State in the battery status screen should display one of the following: Charging, Discharging, Idle, Off, Init.:

```

BSN: XXXXXXXXXXXX ID: 15
SOE: 89% PWR: 2W
Total: <x>Wh
State: Charging
    
```

- If error code **3x6B** (or **Error 186**) - **Battery Comm. Error** appears, the battery communication is disconnected. Check the following:
 - The RS485 control connection to the battery
 - The communication DIP switches settings on the battery
 - The ID DIP switches setting on the battery
- If the state **Idle** is displayed instead of Charging/Discharging, check the following:
 - The system configuration
 - The DC connection
- If **Battery Internal Fault** is displayed, refer to the battery documentation supplied with it. The following is an example fault screen.

```

Battery Internal
Fault <#> (ID: 15)
<xxxx>
<xxxx>
    
```

Fault # - according to battery
 ID - The Modbus ID of the battery
 <xxx> - text

StorEdge Interface LEDs

LED location	Functionality	Troubleshooting
12V IN (left of the main board)	ON -12V (or 13V) is supplied to the main board	N/A
	OFF - No power to the main board	<ul style="list-style-type: none"> ○ Check AC cable is connected to the the power supply (PSU). ○ Check green LED indication on the PSU ○ Check the cable connection between the PSU and the main board
12V OUT (right of the main board)	Not in use	N/A
Green LED on the power supply unit (PSU)	ON - PSU output is OK OFF - no power	Check the AC cable connection

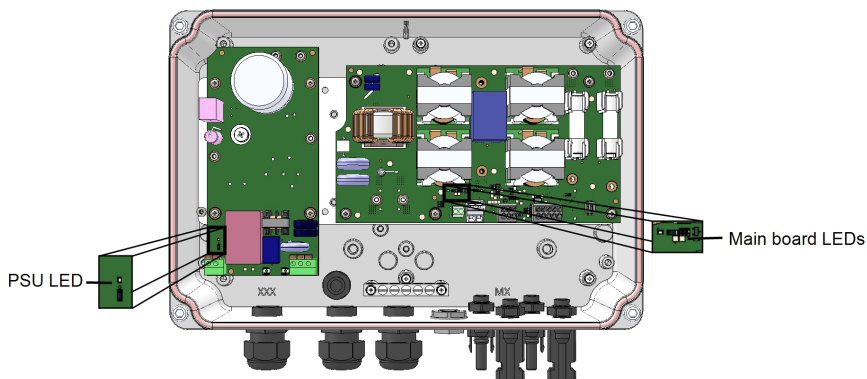

Figure 23: LED locations

Appendix B: Additional Battery Connections

This appendix provides additional options for connecting batteries to the StorEdge Interface.

Pay attention to the wire colors and DIP switch setup of the batteries (refer to *DIP Switch Setup* on page 17). Make sure the first and last device on the RS485 bus is terminated.

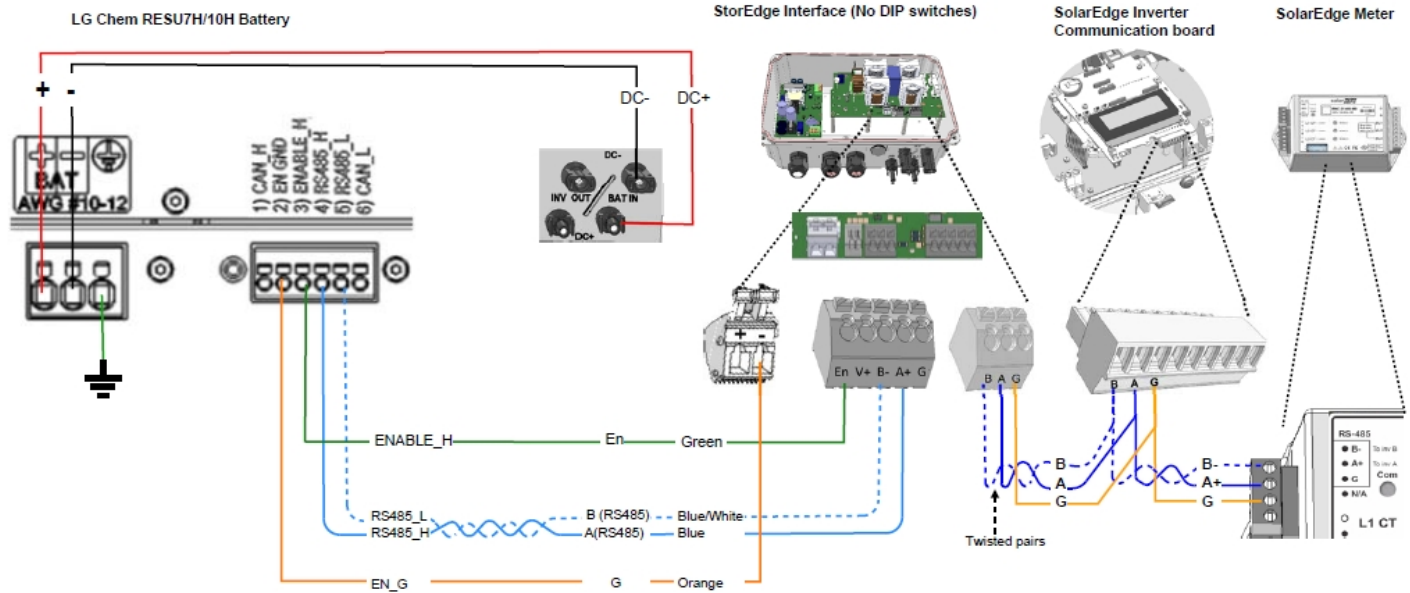

Figure 24: Connections to LG Chem RESU7H/RESU10H battery (single phase inverter and StorEdge Interface without DIP-switches)

Appendix C: StorEdge Interface Technical Specifications

	SESTI		Unit
	SESTI-S1	SESTI-S2	Unit
BATTERY DC INPUT			
Compatible Inverters	Single phase non-HD-Wave Inverters		
Number of Batteries per Interface	1		
Compatible Batteries	LG Chem RESU7H	LG Chem RESU10H	
Max Input Voltage	1000		Vdc
Max Input Current	8.5	17.5	Adc
DC Fuses on Plus and Minus ¹	12A (field replaceable)	25A (field replaceable)	
ADDITIONAL FEATURES			
Battery Communication Interface	RS485		
Meter Communication Interface	RS485		
Pollution degree classification (inside/ outside)	2/ 3		
Maximum altitude rating	2000		m
Overvoltage Category	III		
STOREDGE INTERFACE POWER SUPPLY			
AC Input Voltage (Nominal)	220 / 230		Vac
AC Input Voltage Range	184 - 264.5		Vac
AC Frequency (Nominal)	50 / 60 ± 5		Hz
Max AC Input Current	300		mA
INSTALLATION SPECIFICATIONS			
AC input gland cable diameter / wire cross section	6-13mm / 1-2.5mm ²		
DC input (from the battery)	1 MC4 pair		
DC output (to the inverter)	1 MC4 pair		
Dimensions (HxWxD)	206.6 x 316 x 117.5		mm
Weight	3		kg
Min - Max Operating Temperature	-20 to +50		°C
Humidity (non-condensing)	< 95%		

¹Fuse replacement kits are available from SolarEdge or you can use other fuses with identical ratings.

	SESTI		Unit
	SESTI-S1	SESTI-S2	Unit
Protection Rating	IP65		
Installation	Wall mounted		

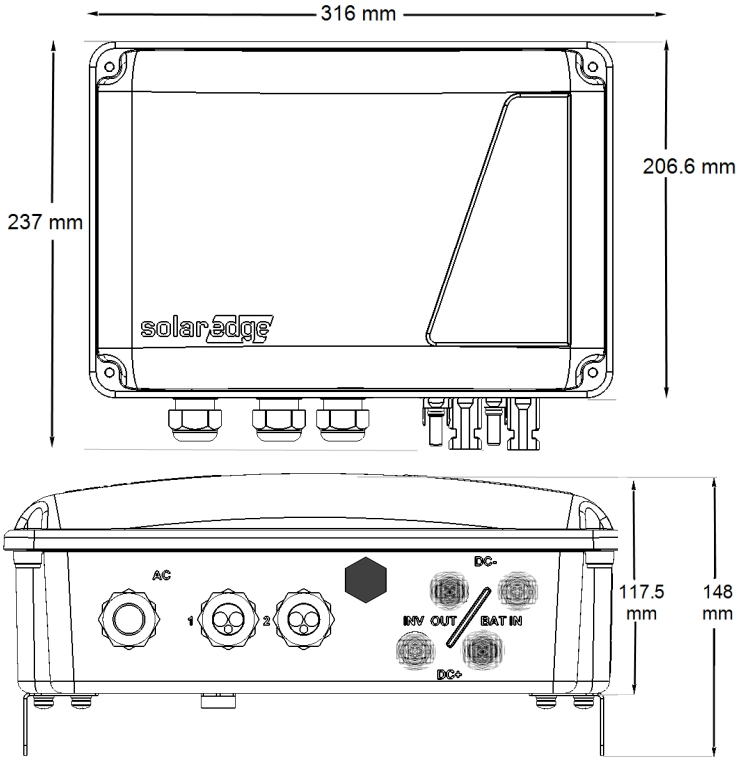

Figure 25: StorEdge Interface dimensions

If you have technical queries concerning our products, please contact our support through SolarEdge service portal:
<http://www.solaredge.com/service/support>

Australia (+61)	1800 465 567
APAC (Asia Pacific) (+972)	073 240 3118
China (+86)	21 6212 5536
France and Belgium (+33)	0800 917 410
DACH and Rest of Europe (+49)	089 454 59730
Italy (+39)	0422 053700
Japan (+81)	03 6262 1223
Netherlands (+31)	0800 0221 089
New Zealand (+64)	0800 144 875
United Kingdom (+44)	0800 028 1183
US & Canada (+1)	510 498 3200
Greece (+30)	00800 125574
Middle East & Africa (+972)	073 240 3118
South Africa (+27)	0800 982 659
Turkey (+90)	216 706 1929
Worldwide (+972)	073 240 3118
Email to:	support@solaredge.com

www.solaredge.com

solaredge